

◆ Home > 6161232140F

Part Number: **6161232140F**

General Description

Color	 Green
Series	616
Description	Green LED 16mm Mounting Hole Indicator
Housing	Polycarbonate
Mounting Method	Lock Washer and Nut
Compliance	Front of Panel
Termination	Solder Blade
Mounting Hole Size	.642"
Panel Thickness	.236"
Lens Material	polycarbonate
Luminous Intensity Typical	110
Forward Current mA	15 mA
Voltage	24 VDC
Operating Temperature	-25 +85
Storage Temperature	-25 +100

Dialight

616 Series LED Panel Mount Indicators for 16mm Mounting Hole



FEATURES / BENEFITS

- ▲ RoHS Compliant
- ▲ Long Life - typically 100K hours
- ▲ Low power consumption - uses up to 90% less energy than an incandescent indicator
- ▲ No heat generated
- ▲ Colors include red, green and yellow
- ▲ Front panel mounting

APPLICATIONS

Dialight's 600 series of metric indicators are designed for a variety of applications such as:

- Main and remote power indication
 - Status Indication
 - Maintenance and warning indication
 - Instrumentation
- ...and many more!

SPECIFICATIONS

- ▲ Voltage requirements: 6, 12 and 24 VDC (No limiting resistor required)
- ▲ Electrical connection through solder terminals
- ▲ Mounting hole size: 0.642 inches (16.3 mm)
- ▲ Maximum panel thickness: 0.236 inches (6.3 mm)
- ▲ Mounts with lock washer and nut (0.217 lbs/ft or 3 Kg/cm torque recommended)
- ▲ Operating Temperature : -25°C to +85°C
- ▲ Storage Temperature: -25°C to +100°C
- ▲ Housing Material: Polycarbonate
- ▲ Lens Material: Polycarbonate to match emitting color

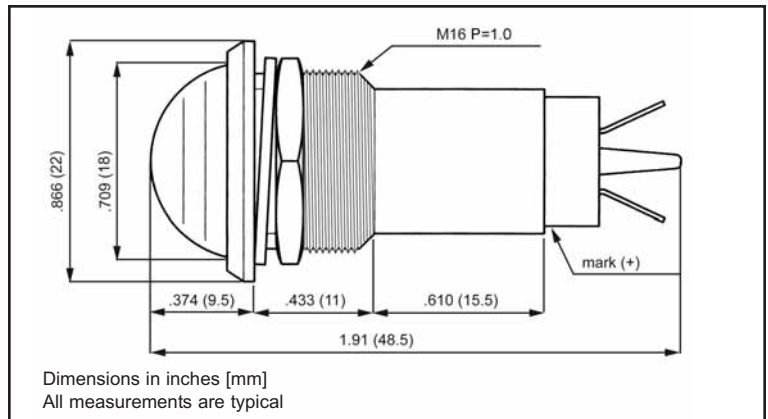

Part Number	Color	Voltage (VDC)	Current (mA)	Typ. Intensity (mcd)	RoHS Compliant
616-1132-120F	Red	6	15	60	✓
616-1232-120F	Green	6	15	110	✓
616-1332-120F	Yellow	6	15	90	✓
616-1132-130F	Red	12	15	60	✓
616-1232-130F	Green	12	15	110	✓
616-1332-130F	Yellow	12	15	90	✓
616-1132-140F	Red	24	15	60	✓
616-1232-140F	Green	24	15	110	✓
616-1332-140F	Yellow	24	15	90	✓

Dialight reserves the right to make changes at any time in order to supply the best product possible.

Dialight Corporation

