

Connectors C 146 D Female insert No. of contacts 40 + PE, 250 V

Part No. C146 10B040 000 2



Series Heavy duty connectors C 146

Abbildung stellvertretend für alle verfügbaren Polzahlen.

Subseries Heavy duty connector C 146 D

COMMON CHARACTERISTICS		
No. of contacts		40 + PE
Contact arrangement (DIN)	DIN EN 60130-9	EN 175 301-801 (DIN 43652)
Type of contact		Stamped/rolled crimp contact
Max. cable diameter		4,1 mm
Weight male insert		53 g
Weight female insert		64 g
ELECTRICAL CHARACTERISTICS		
Rated voltage	DIN EN 60664-1 / IEC 60664-1	250 V~ (400 V~ bei modifizierter Kontaktanordnung) (600 V UL / CSA)
Rated impulse voltage	DIN EN 60664-1 / IEC 60664-1	4000V
Rated current at 40Å°C		10 A
Voltage proof	DIN EN 60512-2, Test 4a / IEC 60512-2, Test 4a	2.200 V
Installation category	DIN EN 60664-1 / IEC 60664-1	III
Insulation group	DIN EN 60664-1 / IEC 60664-1	III b
Insulation resistance	DIN EN 60512-2, Test 3a / IEC 60512-2, Test 3a	$\geq 10^{12}$
Contact resistance	DIN EN 60512-2, Test 2a / IEC 60512-2 Test 2a	≤ 5 m
Clearance	IEC 60664-1	> 3,5 mm
Creepage	IEC 60664-1	> 4,6 mm
Current carrying capacity	DIN EN 60512-3, Test 5b / IEC 60512-2 Test 5b	see derating curves
Pollution degree	DIN EN 60664-1 / IEC 60664-1	3
CLIMATICAL CHARACTERISTICS		
Climatic category	DIN EN 60068-1 / IEC 60068-1	40 / 125 / 21
Upper temperature	IEC 60512-6, Test 11i	+ 125 Å°C / 1000 h
Lower temperatur	IEC 60512-6, Test 11i	- 40 Å°C / 16 h
MECHANICAL CHARACTERISTICS		
IP degree of protection	DIN EN 60529 / IEC 60529	IP20 unmounted
Insertion and withdrawal force	DIN EN 60512-13-2, Test 13b / IEC 60512-13-2, Test 13b	60-90 N
Mechanical lifetime	IEC 60512-5; Test 9 a	≥ 500 mating cycles
MATERIALS		
Insert		PC GV
Colour		grey
FURTHER CHARACTERISTICS		
Termination		crimp
Flammability	UL 94	V-0



250 V, 10 A



600 V, 10 A
600 V, 15 A (Hochstrom/ High Current)



600 V, 10 A

Connectors C 146 D Female insert No. of contacts 40 + PE, 250 V

Part No. C146 10B040 000 2

Series Heavy duty connectors C 146

Subseries Heavy duty connector C 146 D



Abbildung stellvertretend für alle verfügbaren Polzahlen.

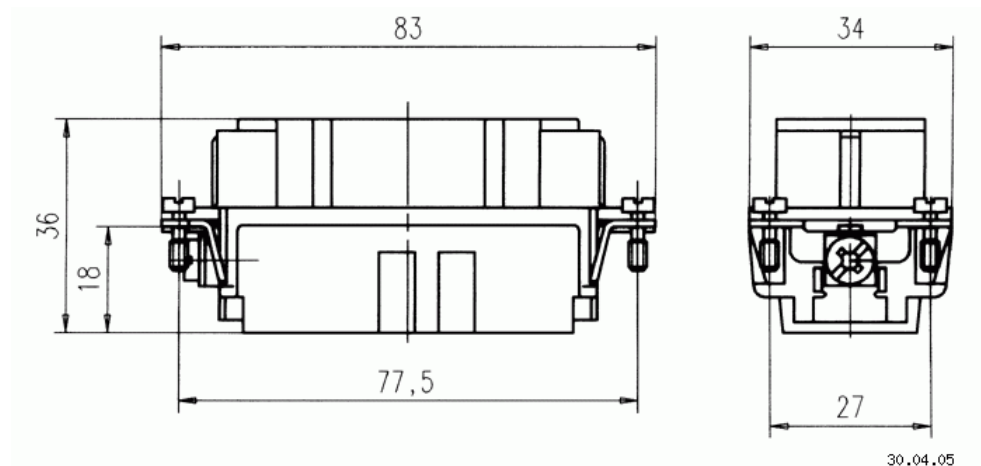

Maßzeichnung Dimensions in mm (Inch)

Connectors C 146 D Female insert No. of contacts 40 + PE, 250 V

Part No. C146 10B040 000 2

Series Heavy duty connectors C 146

Subseries Heavy duty connector C 146 D



Abbildung stellvertretend für alle verfügbaren Polzahlen.

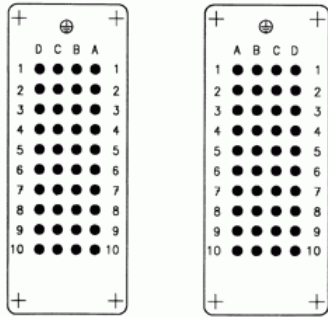

Contact arrangement

