

Connectors C 146 E Female insert No. of contacts 10 + PE, 400 V, with wire protection

Part No. C146 10B010 102 1

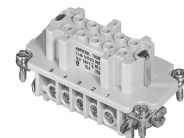

Series Heavy duty connectors C 146

Abbildung stellvertretend für alle verfügbaren Polzahlen.

Subseries Heavy duty connector C 146 E

COMMON CHARACTERISTICS		
No. of contacts		10 + PE
Weight male insert		39 g
Weight female insert		39 g
ELECTRICAL CHARACTERISTICS		
Rated voltage	DIN EN 60664-1 / IEC 60664-1	400 V (600 V UL / CSA)
Rated impulse voltage	DIN EN 60664-1 / IEC 60664-1	6000V
Rated current at 40Å°C		19 A
Voltage proof	DIN EN 60512-2, Test 4a / IEC 60512-2, Test 4a	2.800 V
Installation category	DIN EN 60664-1 / IEC 60664-1	III
Insulation group	DIN EN 60664-1 / IEC 60664-1	III b
Insulation resistance	DIN EN 60512-2, Test 3a / IEC 60512-2, Test 3a	$\geq 10^{12}$
Contact resistance	DIN EN 60512-2, Test 2a / IEC 60512-2 Test 2a	< 5 m
Clearance	DIN VDE 0627	> 4,0 mm
Creepage	DIN VDE 0627	> 6,3 mm
Current carrying capacity	DIN EN 60512-3, Test 5b / IEC 60512-2 Test 5b	see derating curves
Pollution degree	DIN EN 60664-1 / IEC 60664-1	3
CLIMATIC CHARACTERISTICS		
Climatic category	DIN EN 60068-1 / IEC 60068-1	40 / 125 / 21
Upper temperature		+ 125 Å°C / 1000h
Lower temperatur		- 40 Å°C / 16h
MECHANICAL CHARACTERISTICS		
IP degree of protection	DIN EN 60529 / IEC 60529	IP20 unmated
Insertion and withdrawal force	DIN EN 60512-13-2, Test 13b / IEC 60512-13-2, Test 13b	40-50 N
Mechanical lifetime	IEC 60512-5; Test 9 a	≥ 500 mating cycles
MATERIALS		
Insert		PC GV
Colour		grey
Contact plating		silver plated
Knurled screw / Knurled nut		CuZn
FURTHER CHARACTERISTICS		
Termination		screw
Wire gauge		0,25 - 2,5 mmÅ²
Flammability	UL 94	V-0



400 V, 16 A



600 V, 10 A
E 63093



600 V, 15 A
48932

Connectors C 146 E Female insert No. of contacts 10 + PE, 400 V, with wire protection

Part No. C146 10B010 102 1

Series Heavy duty connectors C 146

Subseries Heavy duty connector C 146 E



Abbildung stellvertretend für alle verfügbaren Polzahlen.



Maßzeichnung Dimensions in mm (Inch)

22.02.2007

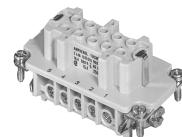
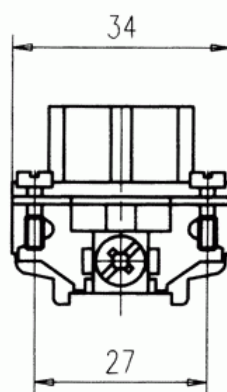
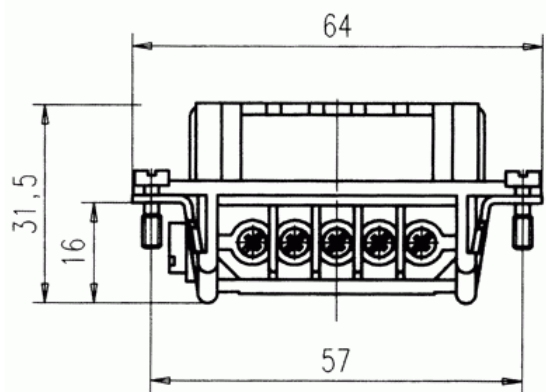
Connectors C 146 E Female insert No. of contacts 10 + PE, 400 V, with wire protection

Part No. C146 10B010 102 1

Series Heavy duty connectors C 146

Subseries Heavy duty connector C 146 E



Abbildung stellvertretend für alle verfügbaren Polzahlen.

Stifteinsatz
Male insert

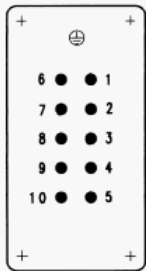

Buchseinsatz
Female insert

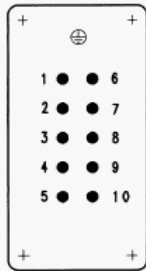

Montageausschnitt (Kontaktträger)
Panel cut out (insert)

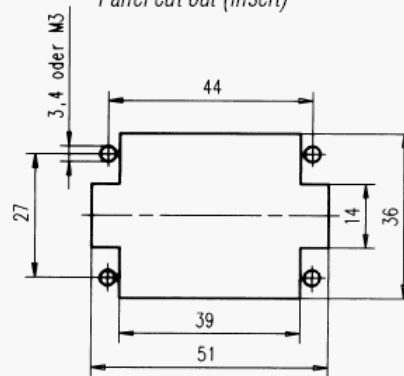

Contact arrangement