

Searches

[Part Information](#) | [Specifications](#) | [Line Drawings](#) | [Assembly Instructions](#) | [Panel Cutout](#)

Quick Search

Global Part Search **NEW!**

Global Search

Company Information

About Tuchel

Amphenol Corporate

Our Commitment

Terms & Conditions

Environmental Information

Online Catalogs

Automotive Interconnect

Industrial Connectors

Search by Family

Search by Part

Process Info Request

Download Catalog

Smart Card Connectors

Contact Information

Find a Sales Location

Distributors

Technical Support

Contact Us

Amphenol Corporation



Part Information:



Part Number: C091 31G008 100 2

Description: Female receptacle, rear mounting, solder termination, silver, 8 DIN

Family: C091D

Click below to add part to your request list.
When you have finished browsing, click "Process Info Request" button.



Specifications

General	Standard	Characteristics
Number of contacts		8
View on termination side of contact insert		
Contact arrangement according to DIN		41 326
Contact arrangement according to IEC		130-9

Electrical		
Rated voltage	IEC 60664-1	150 V
Rated impulse withstand voltage	IEC 60664-1	1200 V
Pollution degree	IEC 60664-1	1
Installation category	IEC 60664-1	I
Insulation group	IEC 60664-1	3
Test voltage	IEC 60664-1	670 V
Current rating	IEC 60512-3 Test 5 b	5 A / +40°C/ _104°F
Insulation resistance	IEC 60512-2 Test 3 a	>10 ¹² Ω
Contact resistance	IEC 60512-2 Test 2 a	<5 m Ω
Climatical		
Climatic category	IEC 60068-1	40 / 85 / 56
Temperature range	IEC 60068-1	-40°C ... +85°C/-40°F ... +185°F
Mechanical		
IP-degree	IEC 60529	IP 67
Insertion and withdrawal forces	IEC 60512-7 Test 13 b	60 N 220.oz

Mechanical operation	IEC 60512-5 Test 9 a	Silver \geq 500 mating cycles Gold \geq 1000 mating cycles
Materials		
Housing		die cast, nickel plated
Dielectric		thermoplastic
Contact plating		silver plated, gold plated
Other Characteristics		
Termination technique		solder, crimp
Wire gauge		solder \leq 0.5mm ² (20-26 AWG) crimp 0.14-1.0mm ² (26-18 AWG)
Flammability		UL 94 VO
Locking system	IEC 103-9	metal screw coupling



Line Drawings

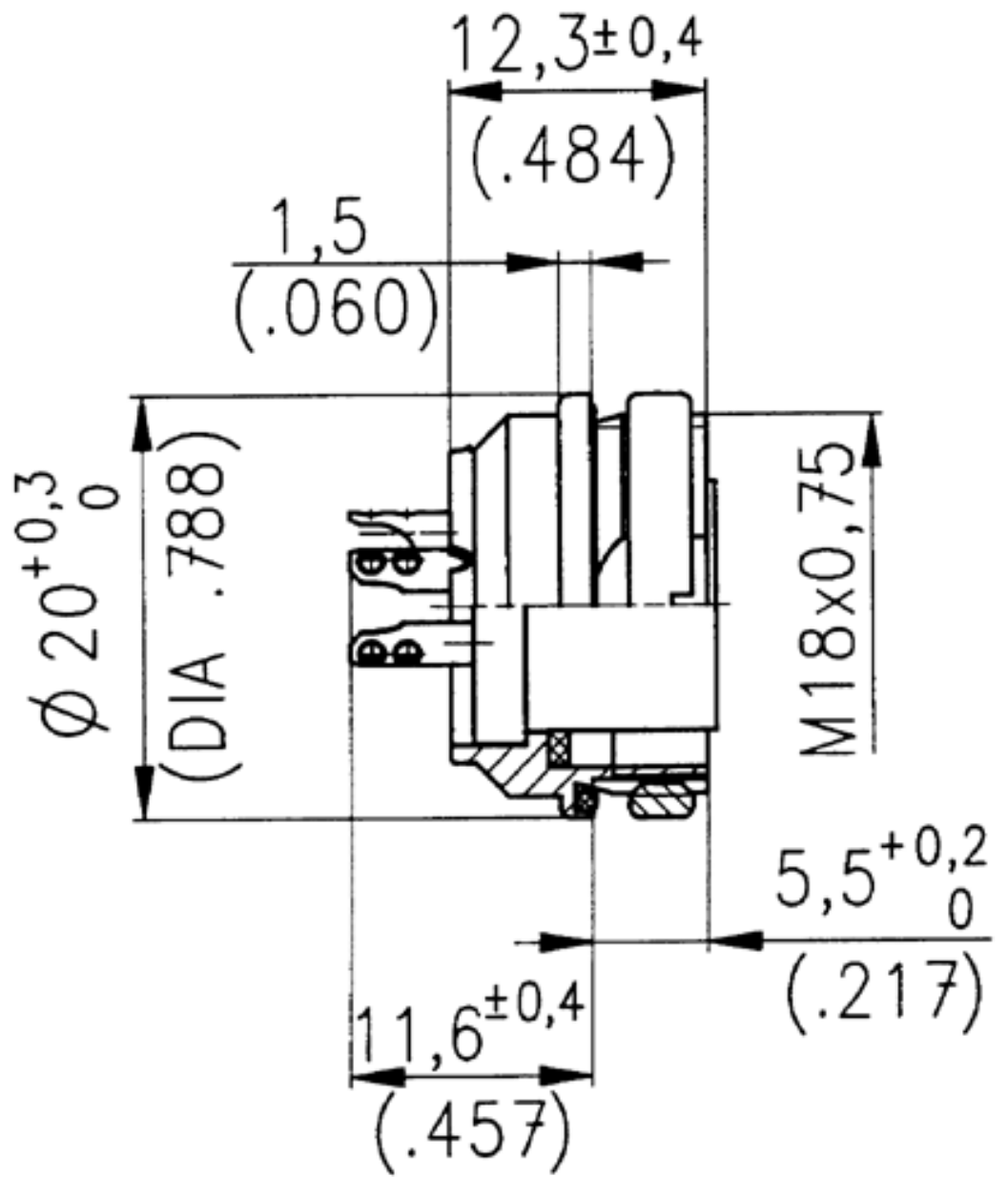

 Panel Cutout

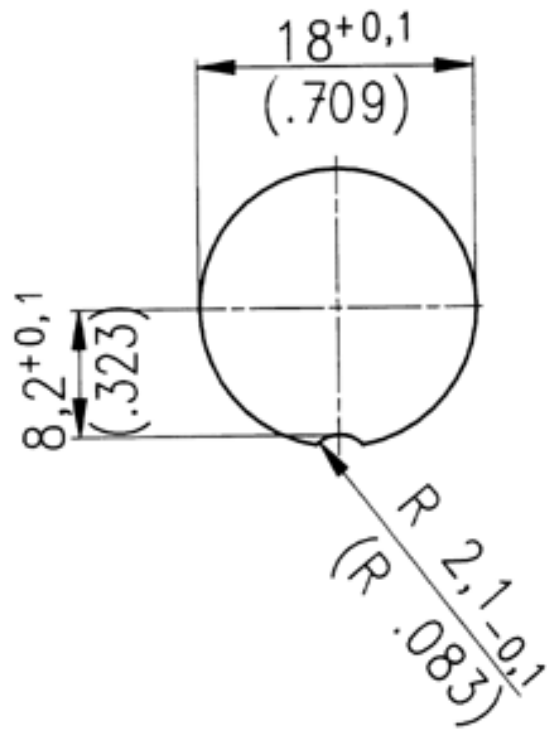

 **Assembly Instructions**

