

Amphenol® 97 Series Standard Cylindrical Connector

12-022-15

**MIL-5015 Style Connectors
widely used for:**

- Factory Automation, Robotics
- Machine Tool, Instrumentation
- Welding Equipment
- Medical Equipment



Amphenol® 97 Series Connectors are
UL recognized and CSA recognized.

Amphenol

Amphenol® 97 Series Connectors

provide the interconnection solution for low cost, general duty applications

Amphenol offers the 97 Series Connector Family - A general duty standard cylindrical connector, MIL-5015 style.

The 97 Series is a widely used connector series for the automotive, robotics, machine tool and welding industries, as well as numerous other commercial applications from heavy equipment to ECG monitoring cables.

Shell components are fabricated from high grade aluminum alloy to provide strength and environmental protection. This family of connectors offers a wide variety of shell styles, contact patterns and accessory options.

The Amphenol® 97 Series design features and benefits:

- **Low cost, general duty non-environmental**
- **Environmental capability with the 417 suffix plus 9767 cable clamp (see page 34)**
- **Solder or crimp termination**
- **UL Recognized, CSA Recognized**
- **Wide selection of shell styles and insert patterns**
- **Wide selection of connector finishes - cadmium or non-cadmium (environmentally friendly zinc alloy)**
- **Threaded coupling, hard dielectric inserts**
- **Solid or split shell construction**
- **Accessories for both individual wire seal and jacketed cable**



RoHS COMPLIANT PRODUCT AVAILABLE – Consult Amphenol Industrial Operations.



Amphenol® 97 Series Connectors with solder contacts



MS3100A



MS3107A



MS3101A



MS3107B



MS3102A



MS3108A



MS3106A



MS3108B



MS3106B

DESIGN CHARACTERISTICS

- Medium to heavy weight cylindrical
- Durable, field-proven design
- Single key/keyway polarization
- Threaded coupling, hard dielectric inserts
- Non-rotating contacts
- Operating temperatures from -55°C to $+125^{\circ}\text{C}$
- Cost effective
- Intermateable and intermountable with existing 97 Series and MIL-5015 connectors
- Underwriters Laboratories approved recognition File E115497
- Canadian Standards Association Certification File LR69183

CUSTOMER OPTIONS

- Solid or split shell construction
- Six shell styles
- 128 contact arrangements, from 1 to 52 circuits
- Alternate insert positioning
- High temperature and potting constructions
- Special plating finishes including black and green zinc alloy
- Optional gold plating on MS contacts
- Thermocouple arrangements available

Connector components are fabricated from high grade aluminum alloy, with a conductive cadmium plate finish and an olive drab chromate after-treatment. Some cable clamps are a zinc alloy with an olive drab/green chromate finish. See how to order page 19 for other finish variations.

Contacts are silver plated with pre-tinned solder cups. Optional gold over silver plating is also available. Inserts for solder style contacts are diallyl-phthalate.

Users should be aware that classes "A" and "B" of MIL-5015 have been cancelled, and these products are no longer qualified.

97 series solder type insert availability, cont.

Insert Number	Total Contacts	Mechanical Spacing		Service Rating	Contact Size				
		Inches	mm		0	4	8	12	16
22-26*	7	1/8	3.18					2	5
22-27	9	1/8	3.18	D			1		
		1/16	1.57	A					8
22-28†	7	1/16	1.57	A				7	
22-34	5	1/8	3.18	D				3	2
24-2	7	1/8	3.18	D				7	
24-5†	16	1/16	1.57	A					16
24-6	8	1/8	3.18	D				3	
		1/16	1.57	A				5	
24-7	16	1/16	1.57	A				2	14
24-9†	2	1/16	1.57	A		2			
24-10	7	1/16	1.57	A			7		
24-11	9	1/16	1.57	A			3	6	
24-12	5	1/16	1.57	A		2		3	
24-16	7	1/8	3.18	D			1		3
		1/16	1.57	A				3	
24-19†	12	1/16	1.57						12
24-20*	11	1/8	3.18	D				2	9
24-21	10	1/8	3.18	D			1		9
24-22*	4	1/8	3.18	D			4		
24-27	7	3/16	4.75	E					7
24-28	24	1/16	1.57	INST.					24
28-1	9	1/8	3.18	D			1	2	
		1/16	1.57	A			2	4	
28-2	14	1/8	3.18	D				2	12
28-3	3	3/16	4.75	E			3		
28-6†	3	1/8	3.18	D		3			
28-8	12	1/16	1.57	A					9
		1/8	3.18	D					1
		3/16	4.75	E				2	
28-9	12	1/8	3.18	D				6	6
28-10	7	1/8	3.18	D				1	
		1/16	1.57	A		2	2	2	
28-11	22	1/16	1.57	A				4	18
28-12	26	1/16	1.57	A					26
28-15†	35	1/16	1.57	A					35
28-16†	20	1/16	1.57	A					20
28-17	15	1/4	6.35	B					1
		1/8	3.18	D					3
		1/16	1.57	A					11
28-18	12	5/16	7.92	C					1
		1/8	3.18	D					5
		1/16	1.57	A					2
				INST.				4	
28-19	10	1/4	6.35	B					2
		1/8	3.18	D					2
		1/16	1.57	A				4	2

Insert Number	Total Contacts	Mechanical Spacing		Service Rating	Contact Size				
		Inches	mm		0	4	8	12	16
28-20	14	1/16	1.57	A				10	4
28-21	37	1/16	1.57	A					37
32-5†	2	1/8	3.18	D	2				
32-6	23	1/16	1.57	A		2	3	2	16
32-7	35	1/16	1.57	A				7	24
				INST.					4
32-8†	30	1/16	1.57	A				6	24
32-13	23	1/8	3.18	D				5	18
32-17	4	1/8	3.18	D		4			
32-414	52	1/16	1.57	A					52
36-1†	22	1/8	3.18	D				4	18
36-5	4	1/16	1.57	A	4				
36-6	6	1/16	1.57	A	2	4			
36-7	47	1/16	1.57	A				7	40
36-8	47	1/16	1.57	A				1	46
36-9	31	1/16	1.57	A		1	2	14	14
36-10	48	1/16	1.57	A					48
36-15	35	1/16	1.57	A					34
		1/8	3.18	D					1
36-403*	52	1/16	1.57	A					52

Not all insert arrangements are currently available for environmental individual wire seal. Consult Amphenol, Sidney, NY for availability.

† Inactive for new military design, but available for replacement or for non-military purposes.

* "MS" number not assigned. Use "97" prefix in place of "MS" in completing catalog number. See how to order, page 19.

♦ Molded-in pin (MIP) insert requires (910) deviation. See how to order, pg. 19.

97 series solder type insert arrangements, cont.

Front view of pin insert or rear of socket insert illustrated.

Items highlighted are most popular and most readily available.

4 Contacts

Insert Arrangement	12SL-844*	14S-2†	16-9	18-4	18-10†	18-13	20-4
Contacts	4#16	4#16	2#12, 2#16	4#16	4#12	3#12, 1#8	4#12
Service Rating	1/16" spacing	INST.	A	D	A	A	D
Insert Arrangement	20-24	22-4†	22-10	22-22	24-22	32-17	36-5
Contacts	2#8, 2#16	2#8, 2#12	4#16	4#8	4#8	4#4	4#0
Service Rating	A	A	E	A	D	D	A

5 Contacts

Insert Arrangement	14S-5	16S-8	18-11	18-20†	18-29†	20-14
Contacts	5#16	5#16	5#12	5#16	5#16	3#12, 2#8
Service Rating	INST.	A	A	A	A	A
Insert Arrangement	22-12	22-13†	22-34†	24-12		
Contacts	2#8, 3#16	1#16, 4#12	3#12, 2#16	2#4, 3#12		
Service Rating	D	E = D; A, B, C, D = A	D	A		

MIL-SPEC SERVICE RATING

		INST.	A	D	E	B	C
Limiting Operating	DC	250	700	1250	1750	2450	4200
Voltages at Sea Level	AC (rms)	200	500	900	1250	1750	3000

See notes 1 and 2 under TEST CURRENT.

INST. service normally for low voltage and currents.

Effective Creepage (nominal)	Inch	1/16	1/8	3/16	1/4	5/16	1
	mm	1.57	3.18	4.75	6.35	7.92	25.40
Mechanical Spacing (nominal)	Inch	1/16	1/8	3/16	1/4	5/16	
	mm	1.57	3.18	4.75	6.35	7.92	

† Inactive for new military design, but available for replacement or for non-military purposes.

* "MS" number not assigned. Use "97" prefix in place of "MS" in completing catalog number. See how to order, page 19.

TEST CURRENT

Contact Size	16	12	8	4	0
Amperes	13	23	46	80	150

NOTE 1: Transients were not considered in calculating these values.

NOTE 2: Limiting operating voltages at 50,000 feet altitude are approximately 25% of the sea level values.

CONTACT LEGEND

16	12	8	4	0	16	12	16 12
				IRON		CONSTANTAN	

97 series solder type insert arrangements, cont.

Front view of pin insert or rear of socket insert illustrated.

Items highlighted are most popular and most readily available.

14 Contacts

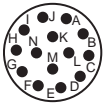
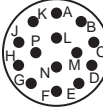
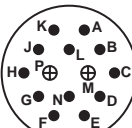
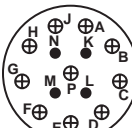
				
Insert Arrangement	20-27	22-19	28-2	28-20
Contacts	14#16	14#16	2#12, 12#16	10#12, 4#16
Service Rating	A	A	D	A

15 Contacts

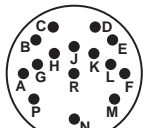
	
Insert Arrangement	28-17
Contacts	15#16
Service Rating	R = B; M, N, P = D; all others = A

16 Contacts

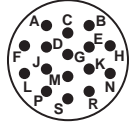
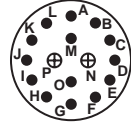
		
Insert Arrangement	24-5†	24-7
Contacts	16#16	2#12, 14#16
Service Rating	A	A

17 Contacts

	
Insert Arrangement	20-29
Contacts	17#16
Service Rating	A

19 Contacts

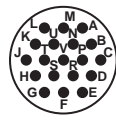
	
Insert Arrangement	22-14
Contacts	19#16
Service Rating	A

20 Contacts

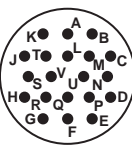
	
Insert Arrangement	28-16†
Contacts	20#16
Service Rating	A

22 Contacts

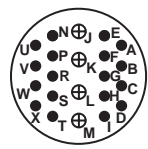
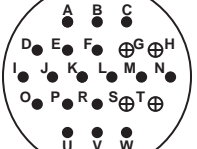
		
Insert Arrangement	28-11	36-1†
Contacts	4#12, 18#16	4#12, 18#16
Service Rating	A	D

23 Contacts

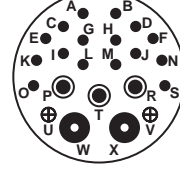
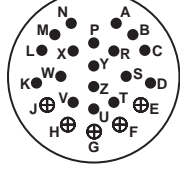
		
Insert Arrangement	32-6	32-13
Contacts	2#4, 3#8, 2#12, 16#16	5#12, 18#16
Service Rating	A	D

24 Contacts

	
Insert Arrangement	24-28
Contacts	24#16
Service Rating	INST.

26 Contacts

	
Insert Arrangement	28-12
Contacts	26#16
Service Rating	A

30 Contacts

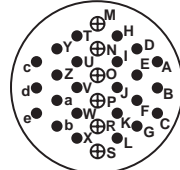
	
Insert Arrangement	32-8†
Contacts	6#12, 24#16
Service Rating	A

31 Contacts

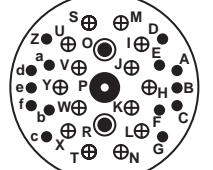
	
Insert Arrangement	36-9
Contacts	1#4, 2#8, 14#12, 14#16
Service Rating	A

97 series solder type how to order

Example of part number for solder type connectors is given below.

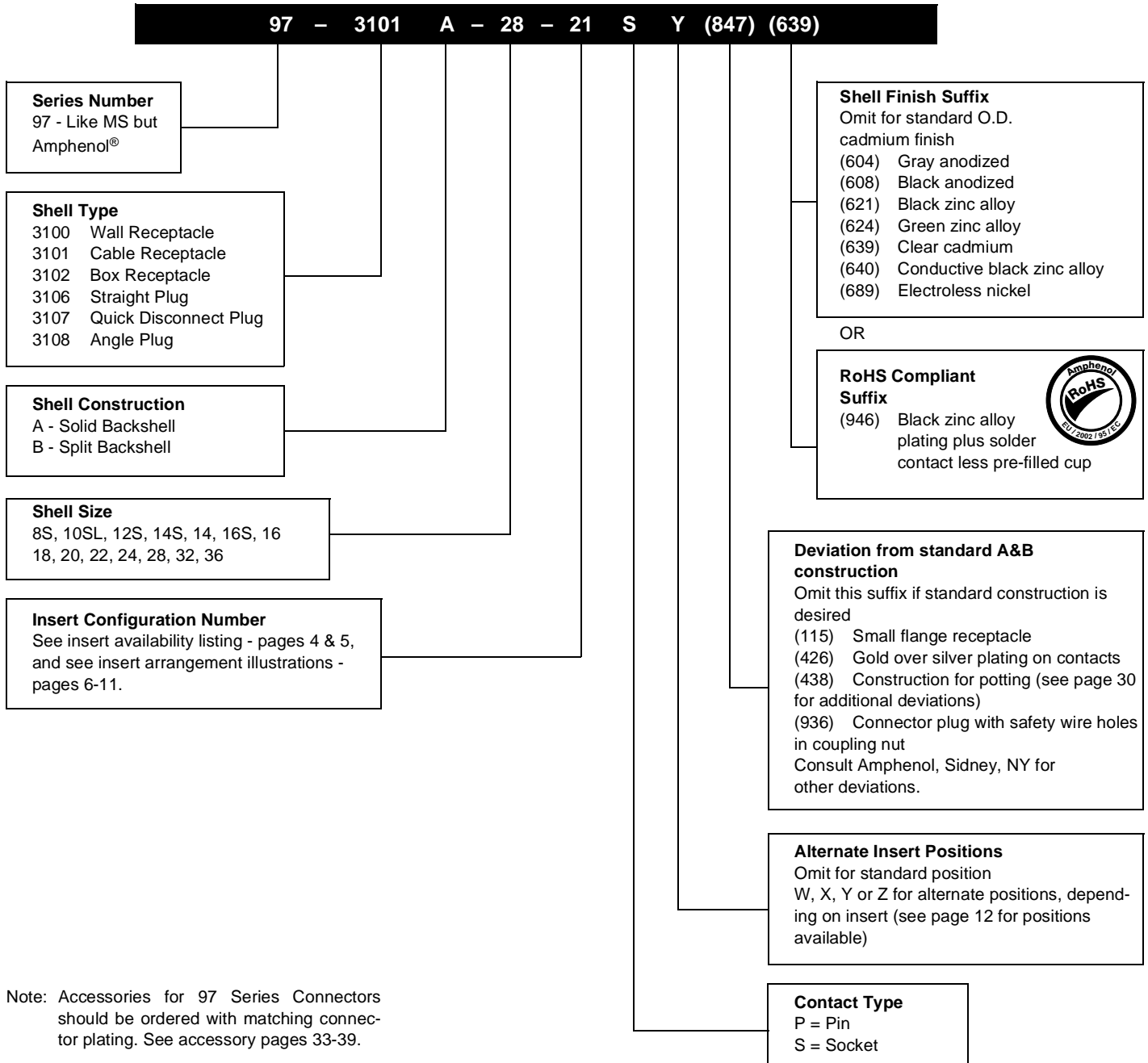

Note: Accessories for 97 Series Connectors should be ordered with matching connector plating. See accessory pages 33-39.

Amphenol Industrial 97 Series



97 Series Industrial Cylindrical Connectors

Amphenol's 97 Series is the lowest cost, cylindrical interconnect solution utilizing the proven 5015 family connector style. 97 Series offers: six shell options, solid and split, 128 different contact arrangements, 1 to 52 circuits, one of the largest selections of insert patterns on the connector market, crimp, solder, thermocouple and PCB (100 suffix) contacts, all which makes 97 Series one of the most versatile of Amphenol's connector with utilization in many markets.

Applications

- | | |
|----------------------------------------------------------------------------------------------------------------------------------------------------------------------------------------------------------------------------------------------------------------------------------------------------------------------------------------------------------------------------------------------------------------------------------------------------------------------------------------------------------------------------------------------------------------------------------------------------------------------------------------------------------------------------------------------------------------------------------------------------------------------------------------------------------------------------------------------------------------------------------------------------------------------------------------------------------------------------------------------------------------------------------------------------------------|--------------------------------------------------------------------------------------------------------------------------------------------------------------------------------------------------------------------------------------------------------------------------------------------------------------------------------------------------------------------------------------------------------------------------------------------------------------------------------------------------------------------------------------------------------------------------------------------------------------------------------------------------------------------------------------------------------------------------------------------------------------------------------------------------------------------------------------------------------------------------------------------------------------------------------------------------------------------------------------------------------------------------------------------------------------|
| <ul style="list-style-type: none">▪ Machine Tool/Factory Automation<ul style="list-style-type: none">○ Power and Cutting Tools○ Instrumentation Distribution○ Control Panels○ CNC Milling Machines▪ Welding Equipment<ul style="list-style-type: none">○ Station, Robotic and Portable○ Factory Construction○ Garage Welders○ Auxiliary Equipment<ul style="list-style-type: none">▪ Spool Guns▪ Wire Feeders▪ Motors<ul style="list-style-type: none">○ Servo Motors○ Motion Control○ Power Motors○ Stepper Motors○ Encoders▪ Mining Equipment<ul style="list-style-type: none">○ Mining Shovels○ Seismic Sensing Equipment○ Seismic Geophones▪ Robotics<ul style="list-style-type: none">○ Power and Multi Axis Control Equipment○ Factory Automation | <ul style="list-style-type: none">▪ Semiconductor Equipment<ul style="list-style-type: none">○ Automated Assembly and Test Equipment○ Equipment Specifically for CEM Assembly○ Semiconductor Test Equipment Mfg'ers▪ Off Road Vehicles<ul style="list-style-type: none">○ Concrete Road Building○ Precision Farm Monitoring Equipment○ GPS in Heavy Duty Trucks▪ Test & Measurement<ul style="list-style-type: none">○ Temperature Chambers○ Vibration Controllers and Shakers○ RF Amplifiers○ Power Supplies▪ Medical Equipment<ul style="list-style-type: none">○ Medical X-Ray/Ultrasound Equipment○ Blood Analyses○ Medical Coaches/Vehicles○ ECG Monitoring Cables▪ Motion Sensors<ul style="list-style-type: none">○ Bar Code Scanners○ Flame Sensors○ Temperature Controls |
|----------------------------------------------------------------------------------------------------------------------------------------------------------------------------------------------------------------------------------------------------------------------------------------------------------------------------------------------------------------------------------------------------------------------------------------------------------------------------------------------------------------------------------------------------------------------------------------------------------------------------------------------------------------------------------------------------------------------------------------------------------------------------------------------------------------------------------------------------------------------------------------------------------------------------------------------------------------------------------------------------------------------------------------------------------------|--------------------------------------------------------------------------------------------------------------------------------------------------------------------------------------------------------------------------------------------------------------------------------------------------------------------------------------------------------------------------------------------------------------------------------------------------------------------------------------------------------------------------------------------------------------------------------------------------------------------------------------------------------------------------------------------------------------------------------------------------------------------------------------------------------------------------------------------------------------------------------------------------------------------------------------------------------------------------------------------------------------------------------------------------------------|

Key Benefits

- | | |
|-------------------------------------------------------------------------------------------------------------------------------------------------------------------------------------------------------------------------------------------------------------------------------------------------------------------------------------------------------------------------------------------------------------------------------------------------------------------------------------------------------------------------------------------------------------------------------------------------------------------------------------------------------------------------------------------------------------------------------------------------------------------------------------------------------------------------------------------------------------------------|--------------------------------------------------------------------------------------------------------------------------------------------------------------------------------------------------------------------------------------------------------------------------------------------------------------------------------------------------------------------------------------------------------------------------------------------------------------------------------------------------------------------------------------------------------------------------------------------------------------------------------------------------------------------------------------------------------------------------------------------------------------------------------------------------------|
| <ul style="list-style-type: none">▪ Keyway Polarization<ul style="list-style-type: none">○ Prevents incorrect mating▪ Inserts easily removed from shell<ul style="list-style-type: none">○ Minimizes repair time thus saving money▪ Non-Rotating Contacts<ul style="list-style-type: none">○ Increases productivity by ease of soldering▪ Solder, Crimp, Thermocouple and PCB contacts<ul style="list-style-type: none">○ Provides wide range of connector solutions▪ Multiple Wire Gauges: 0 to 30 AWG<ul style="list-style-type: none">○ Flexibility in Design▪ Pre-filled Solder Cup<ul style="list-style-type: none">○ Increase productivity by reducing preparation work. | <ul style="list-style-type: none">▪ Multiple finishes including RoHS compliant<ul style="list-style-type: none">○ O.D. Cadmium, Black Zinc Cobalt, Clear Cadmium, Electroless Nickel and more offer large variety of environmental finishes for any application.▪ Alternative Insert Rotations<ul style="list-style-type: none">○ Increase design options within shell size.▪ Hard Plastic (Diallyl-Phthalate) Inserts<ul style="list-style-type: none">○ Resists breakage and extends connector life.▪ Many Connector Accessories<ul style="list-style-type: none">○ Cable clamps○ Gaskets and Protection Caps○ Cap and Chain Assemblies |
|-------------------------------------------------------------------------------------------------------------------------------------------------------------------------------------------------------------------------------------------------------------------------------------------------------------------------------------------------------------------------------------------------------------------------------------------------------------------------------------------------------------------------------------------------------------------------------------------------------------------------------------------------------------------------------------------------------------------------------------------------------------------------------------------------------------------------------------------------------------------------|--------------------------------------------------------------------------------------------------------------------------------------------------------------------------------------------------------------------------------------------------------------------------------------------------------------------------------------------------------------------------------------------------------------------------------------------------------------------------------------------------------------------------------------------------------------------------------------------------------------------------------------------------------------------------------------------------------------------------------------------------------------------------------------------------------|

Electrical Features

Current Rating	13 to 150 Amperage	Contact Size	30 AWG to 0 AWG
Operating Temperature	-55°C to +125°C	UL and CSA Approval	E115497 & LR69183
Voltage Rating	200 VAC to 3000 VAC 250 DAC to 4200 VDC	Durability	500 mating cycles 10,000 cycles with Radsok® contacts

97 Series RoHS Compliant

Amphenol Industrial is **RoHS** compliant - 1 year before the European Union directive! Existing products that do not meet these requirements can easily be changed to meet these environmental guidelines through simple modifications.

ROHS Compliant Mod Code	
(431) Solder Contacts less pre filled solder cup	
(621) Black Zinc Cobalt connector plating	
(689) Electroless Nickel connector plating	

Part Number Identification	
Non-ROHS Solder P/N	97-3106A14S-6P
ROHS Solder P/N	97-3106A14S-6P (431)(621)
Non-ROHS Crimp P/N	97-4106A14S-6P
ROHS Crimp P/N	97-4106A14S-6P (621)

How to build a part number

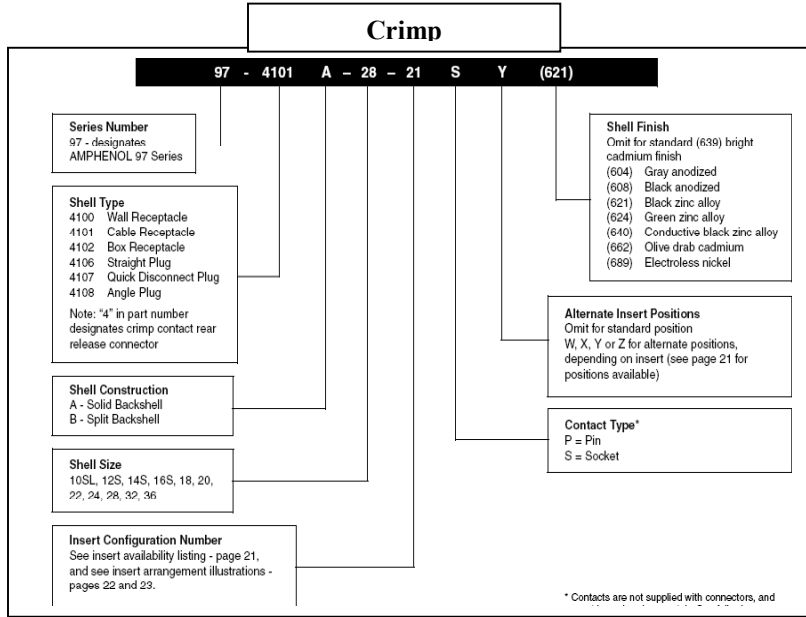
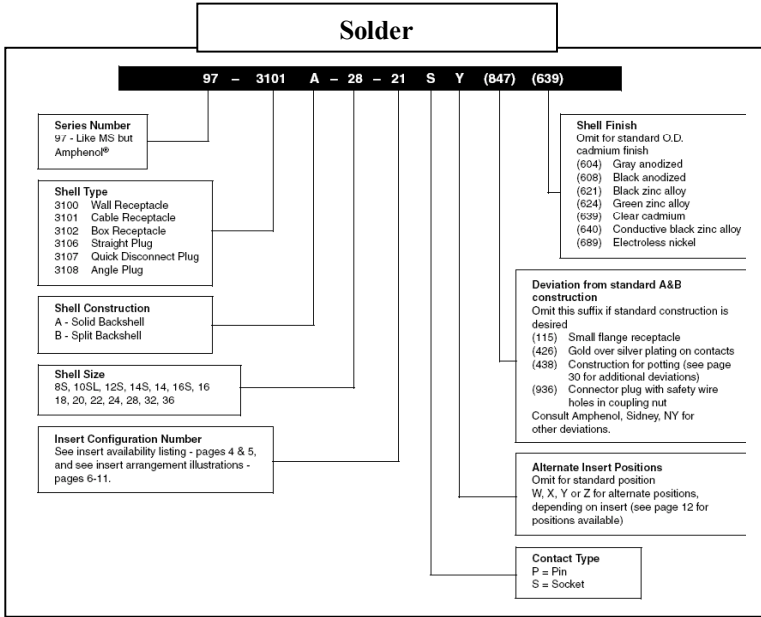

Breaking 97 Series part numbers down to component level

Example:

	Top Level Part	Shell	Insert
Solder P/N	97-3106A-18-1S becomes 97-3101A-28-21SY(639)	97-3106A-18(850) 97-3101A-28(639)	97-18-1S 97-28-21S
Crimp Part	97-4106A-20-27P(639) 97-4101A-28-21SY(621)	97-3106A-20(639)(850) 97-3101A-28(621)(850)	97-420-27P 97-428-21S

97 Series Environmental Adapter Kit 97-283-XX

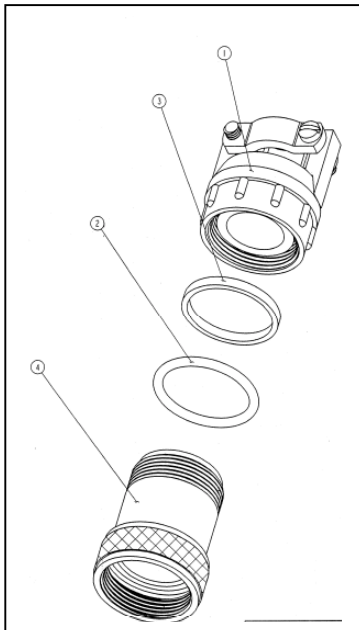

POS	QTY	PART NUMBER	DESCRIPTION	NOTE
4	1	SEE NOTE 1	ADAPTER, LONG	
3	1		WASHER, SEALING, PLUG SHELL	(7)
2	1		GASKET, ADAPTER, SEALING	(5)
1	1		BACKSHELL	

- DIAMETER INDICATED IS THE MINIMUM FREE INSIDE DIAMETER OF EITHER THE CABLE CLAMP OR GLAND AND DETERMINES THE MAXIMUM ACCEPTABLE CABLE DIAMETER.
- INDICATED ITEM USED WITH 97-3106E, 97-3107E, 97-4106E, AND 97-4107E ASSEMBLIES ONLY.
- ADD APPLICABLE DEVIATION FOR DESIRED PLATING:
DEVIATION PLATING:
--- OLIVE DRAB CADMIUM
(604) GREY ANODIZE
(608) BLACK ANODIZE
(621) BLACK ZINC ALLOY
(624) GREEN ZINC ALLOY
(639) CLEAR CADMIUM
(676) BRIGHT NICKEL
(689) ELECTROLESS NICKEL
- INDICATED ITEM TO BE INSTALLED INTO ADAPTER (10-61705-XXX) OF 97-3106A-XX (850).
- IDENTIFY PACKAGE WITH APPLICABLE 97- PART NUMBER.
- PACKAGE PER PRODUCTION PROCESS SHEET.
- SEE WORK ORDER FOR PERMISSIBLE ADDITIONAL OR ALTERNATE STAMPING.
- SEE SEPARATE PARTS LIST FOR COMPONENT PART NUMBERS AND QUANTITIES.

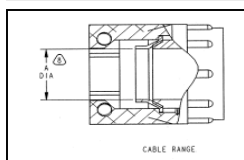

Amphenol Part Number	Size	A DIA	
		Free	Closed
97-283-10SL (XXX)	10SL	.302	.094
97-283- 12 (XXX)	12S & 12	.302	.094
97-283- 14 (XXX)	14S & 14	.428	.230
97-283- 16 (XXX)	16S & 16	.515	.316
97-283- 18 (XXX)	18	.614	.378
97-283- 28 (XXX)	20	.738	.445
97-283- 22 (XXX)	22	.738	.445
97-283- 28 (XXX)	24	.926	.611
97-283- 32 (XXX)	32	1.20	.922
97-283- 36 (XXX)	36	1.363	.922

Assembly Instruction Sheet for Environmental 97E Connectors is L-2089