

3M™ Pak 100 Preassembled Wiremount Socket

.100" × .100" for .050" Pitch Cable

891 Series



- Preassembled, terminates faster than two-piece sockets
- "Sword" packaging makes easy loading of manual and semi-automatic assembly equipment
- "Bumps" prevent premature latch locking during shipment
- Optional double-sided adhesive pull tab for easy unplugging
- Double-recessed cover for cable terminating from either side eliminates need for single-recessed cover connectors
- *RoHS compliant

Date Modified: June 14, 2005

TS-0449-20
Sheet 1 of 2

Physical

Insulation

Material: Glass Filled Polyester (PBT)

Flammability: UL 94V-0

Color: Gray

Contact

Material: Phosphor Bronze (C510)

Plating:

Underplating: 100 μ" [2.54 μm] Nickel - QQ-N-290, Class 2

Wiping Area: 30 μ" [0.76 μm] Gold - MIL-G-45204, Type II, Grade C

Wire Accommodation: 26 & 28 AWG Stranded

Marking: 3M Logo, Part Identification Number and Orientation Triangle

Electrical

Current Rating: 1 A

Insulation Resistance: $> 1 \times 10^9 \Omega$ at 500 VDC

Withstanding Voltage: 1000 Vrms at Sea Level

Environmental

Temperature Rating: -55°C to +105°C

RoHS = Directive 2002/95/EC, Restriction of the Use of Certain Hazardous Substances in Electrical and Electronic Equipment
"RoHS compliant" means that the product or part does not contain any of the following substances in excess of the following maximum concentration values in any homogeneous material: (a) 0.1% (by weight) for each of lead, mercury, hexavalent chromium, polybrominated biphenyls or polybrominated diphenyl ethers; or (b) 0.01% (by weight) for cadmium. Lead, mercury, cadmium, or hexavalent chromium may be present in the product or part in an exempt application as listed in the Annex to the RoHS Directive.

UL File No.: E68080

3M™ Pak 100 Preassembled Wiremount Socket

.100" × .100" for .050" Pitch Cable

891 Series



Contact Quantity	Dimensions	
	A	B
10	.68 [17.3]	.53 [13.5]
14	.88 [22.4]	.73 [18.5]
16	.98 [24.9]	.83 [21.1]
20	1.18 [30.0]	1.03 [26.2]
24	1.38 [35.1]	1.23 [31.2]
26	1.48 [37.6]	1.33 [33.8]
30	1.68 [42.7]	1.53 [38.9]
34	1.88 [47.7]	1.73 [43.9]
36	1.98 [50.3]	1.83 [46.5]
40	2.18 [55.4]	2.03 [51.6]
44	2.38 [60.5]	2.23 [56.4]
50	2.68 [68.1]	2.53 [64.1]
60	3.18 [80.0]	3.03 [80.0]

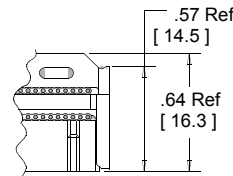
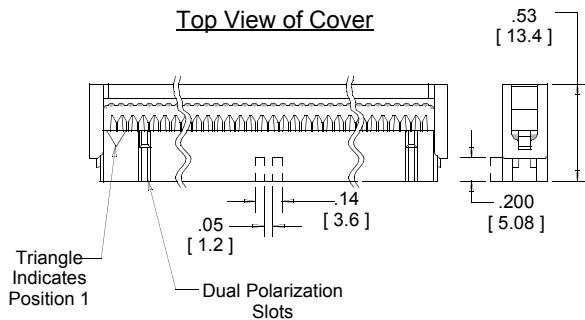
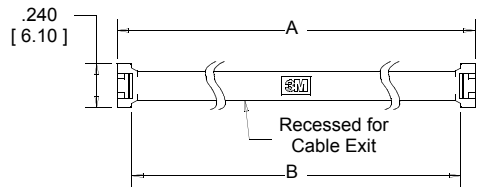
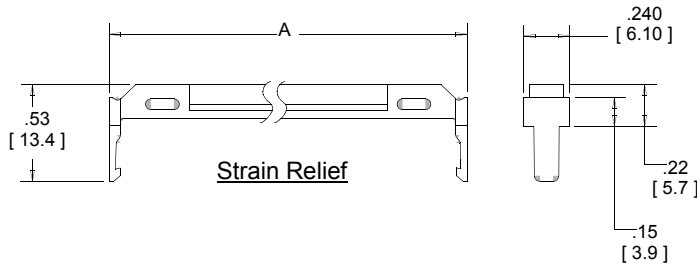

Assembled Height with Standard Plastic Strain Relief

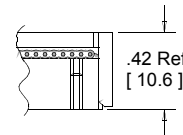

Assembled Height Without Strain Relief

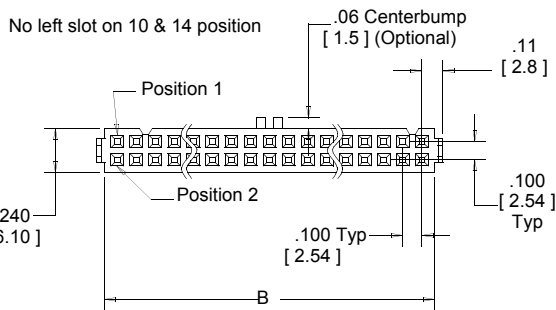

Bottom View of Body

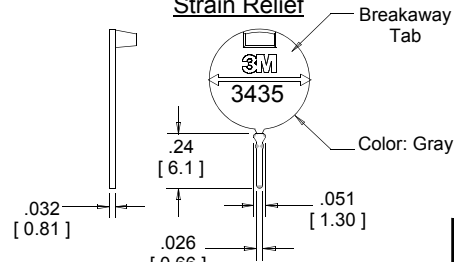

3435-0 Keying Plug (Optional: Order Separately)

Inch [mm]			
Tolerance Unless Noted			
	.0	.00	.000
inch	±.1	±.01	±.005

[] Dimensions for Reference Only

Note: See TS-0721 for mating post pattern.

Ordering Information

Sockets
891XX-0XXXXX

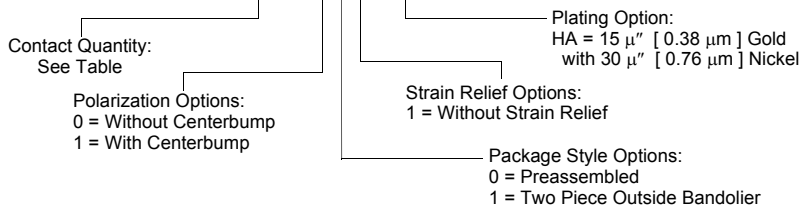

Strain Relief
(Order Separately)
3448-891XX

Contact Quantity:
See Table

Pull Tabs
(Order Separately)

See TS-0496.

Assembly tools: 3640 press (or equivalent), 3443-107N locator plate, 3442-9 platen.

TS-0449-20
Sheet 2 of 2

Important Notice

All statements, technical information, and recommendations related to 3M's products are based on information believed to be reliable, but the accuracy or completeness is not guaranteed. Before using this product, you must evaluate it and determine if it is suitable for your intended application. You assume all risks and liability associated with such use. Any statements related to the product which are not contained in 3M's current publications, or any contrary statements contained on your purchase order shall have no force or effect unless expressly agreed upon, in writing, by an authorized officer of 3M.

3M

Electronics

6801 River Place Blvd.
Austin, TX 78726-9000
800/328-1368
www.3M.com/electronics

Warranty; Limited Remedy; Limited Liability.

This product will be free from defects in material and manufacture for a period of one (1) year from the time of purchase. **3M MAKES NO OTHER WARRANTIES INCLUDING, BUT NOT LIMITED TO, ANY IMPLIED WARRANTY OF MERCHANTABILITY OR FITNESS FOR A PARTICULAR PURPOSE.** If this product is defective within the warranty period stated above, your exclusive remedy shall be, at 3M's option, to replace or repair the 3M product or refund the purchase price of the 3M product. **Except where prohibited by law, 3M will not be liable for any indirect, special, incidental or consequential loss or damage arising from this 3M product, regardless of the legal theory asserted.**



*Minimum 10%
Post-Consumer Fiber*

Printed in USA.

© 3M 2005