



(click to enlarge)

**Clear Anodized
(Open View)**

(click to enlarge)

**Clear Anodized
(Assembled View)**

(click to enlarge)

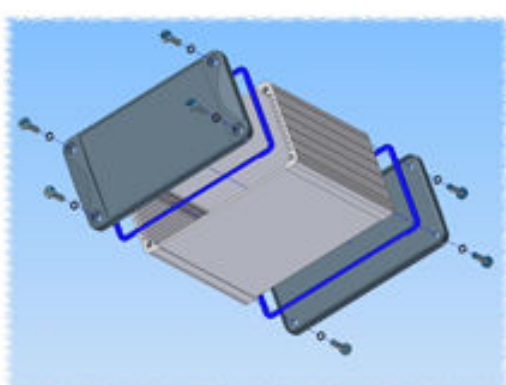
**Flanged Version
Clear Anodized
(Assembled View)**

(click to enlarge)



















Key Features:

- Watertight - [heavy duty extruded enclosures](#) designed to house P.C. boards or for equipment interfacing.
- Sized for standard Eurocards.
- P.C. boards mount horizontally by sliding into internal slots extruded into the enclosure body.
- Rugged body constructed from one piece, extruded aluminum with a minimum thickness of .06" (1.5 mm).
- Extruded aluminum body includes a recessed area for labels or membrane keypad.
- End panels are rugged - yet easy to machine - diecast aluminum with full perimeter self-adhesive gaskets.
- Designed to meet IP 65 ratings.
- Choice of two versions - end panels without flange or with flange (for shelf or wall mounting).

Includes:

- Two diecast aluminum end panels - painted in a durable, black satin powder paint.
- Extruded, aluminum body (choice of either clear anodized or black powder paint finish).
- Two closed cell polyethylene foam - end plate gaskets & rubber "O" rings for assembly screws.
- All hardware and self-adhesive feet.





REGULAR FRONT & BACK END PANELS (NO MOUNTING FLANGE)

Part Number	Extruded Body Color	Reader File	 Drawing File Size	AutoCAD .dwg Files (zipped)	.zip File Size	3D Solid Model .igs & .stp files (zipped)	3D .zip File Size	Units	Length	Width	Height
1457C801 1457C801BK	Clear Black		274K		238K		258K	Inches	3.15	2.32	1.21
								mm	80	59	30.9
1457C1201 1457C1201BK	Clear Black		282K		248K		258K	Inches	4.73	2.32	1.21
								mm	120	59	30.9
1457K1201 1457K1201BK	Clear Black		458K		314K		437K	Inches	4.73	3.30	1.73
								mm	120	84	44.1
1457K1601 1457K1601BK	Clear Black		451K		311K		437K	Inches	6.30	3.30	1.73
								mm	160	84	44.1
1457N1201 1457N1201BK	Clear Black		436K		342K		300K	Inches	4.73	4.09	2.15
								mm	120	104	54.6
1457N1601 1457N1601BK	Clear Black		437K		338K		300K	Inches	6.30	4.09	2.15
								mm	160	104	54.6



(click to enlarge)

**Flanged Version
Clear Anodized
(Bottom View)**
FLANGED VERSION

Part Number	Extruded Body Color	Reader File	 Drawing File Size	AutoCAD .dwg Files (zipped)	.zip File Size	3D Solid Model .igs & .stp files (zipped)	3D .zip File Size	Units	Length	Width	Height
1457C802 1457C802BK	Clear Black		286K		259K		280K	Inches	3.15	2.32	1.21
								mm	80	59	30.9

1457C1202 1457C1202BK	Clear		284K		260K		280K	Inches	4.73	2.32	1.21
	Black							mm	120	59	30.9
1457K1202 1457K1202BK	Clear		461K		310K		479K	Inches	4.73	3.30	1.73
	Black							mm	120	84	44.1
1457K1602 1457K1602BK	Clear		457K		318K		479K	Inches	6.30	3.30	1.73
	Black							mm	160	84	44.1
1457N1202 1457N1202BK	Clear		454K		341K		330K	Inches	4.73	4.09	2.15
	Black							mm	120	104	54.6
1457N1602 1457N1602BK	Clear		449K		336K		330K	Inches	6.30	4.09	2.15
	Black							mm	160	104	54.6

Color Options:



(click to enlarge)

- Choose either clear anodized (left) finish or black powder paint (right).
- Note that the diecast aluminum front & back panels are both finished in black powder paint.

Heavy Duty:

DESIGNED FOR TOUGH ENVIRONMENTS !



(click to enlarge)



(click to enlarge)

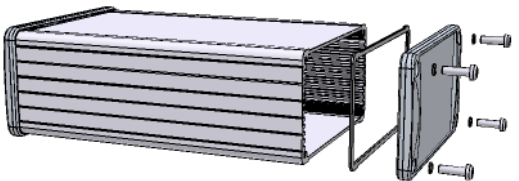
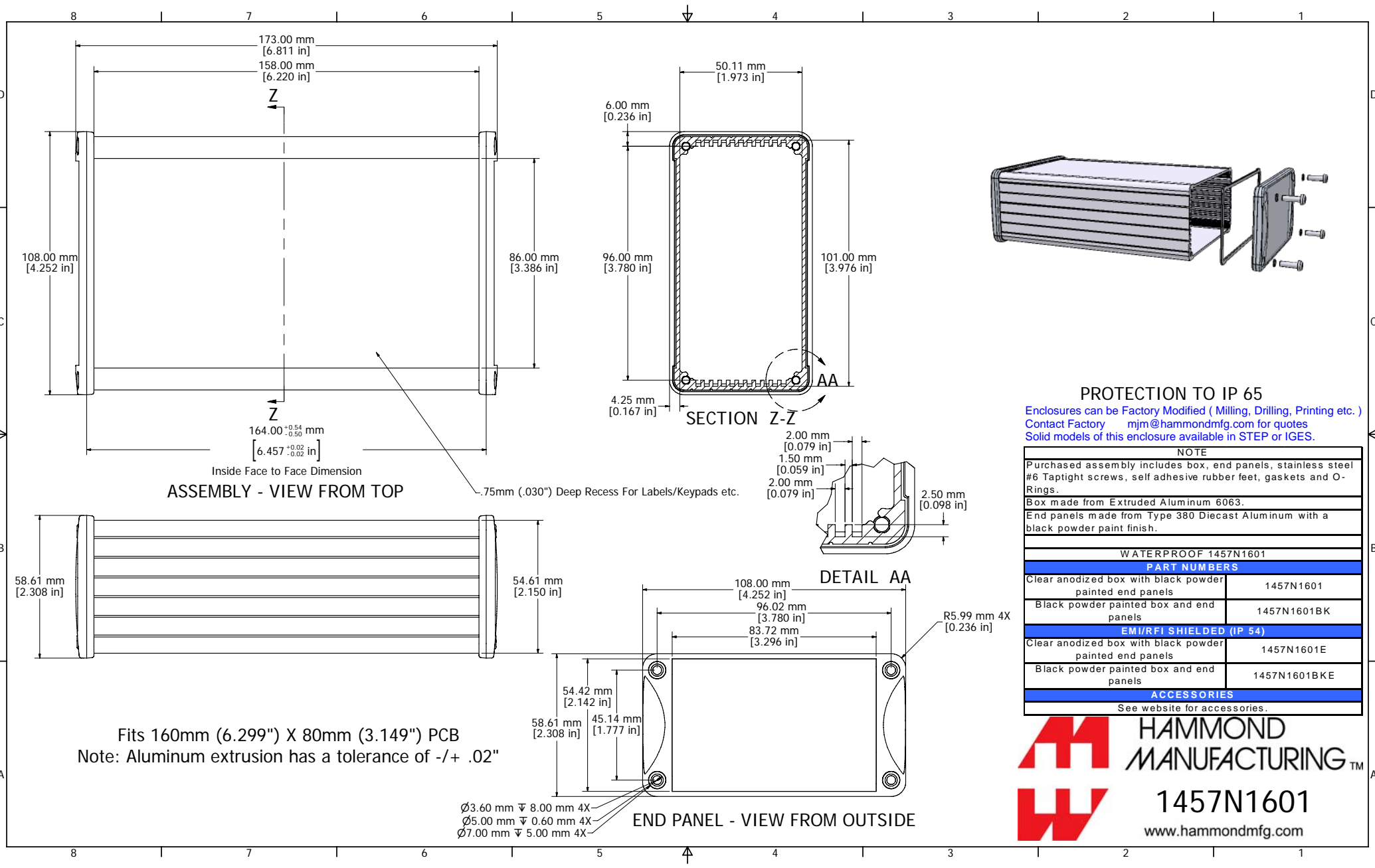

PROTECTION TO IP 65

Enclosures can be Factory Modified (Milling, Drilling, Printing etc.)
 Contact Factory mjm@hammondmfg.com for quotes
 Solid models of this enclosure available in STEP or IGES.

NOTE	
Purchased assembly includes box, end panels, stainless steel #6 Taptight screws, self adhesive rubber feet, gaskets and O-Rings.	
Box made from Extruded Aluminum 6063.	
End panels made from Type 380 Diecast Aluminum with a black powder paint finish.	
WATERPROOF 1457N1601	
PART NUMBERS	
Clear anodized box with black powder painted end panels	1457N1601
Black powder painted box and end panels	1457N1601BK
EMI/RFI SHIELDED (IP 54)	
Clear anodized box with black powder painted end panels	1457N1601E
Black powder painted box and end panels	1457N1601BKE
ACCESSORIES	
See website for accessories.	

HAMMOND MANUFACTURING™

1457N1601

www.hammondmfg.com